

Main (OB1)

Block title: "Main Program Sweep (Cycle)"

Network 1:

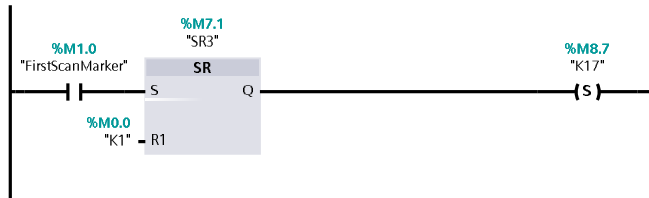

Network 2:

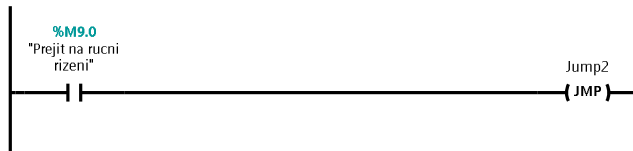

Network 3:

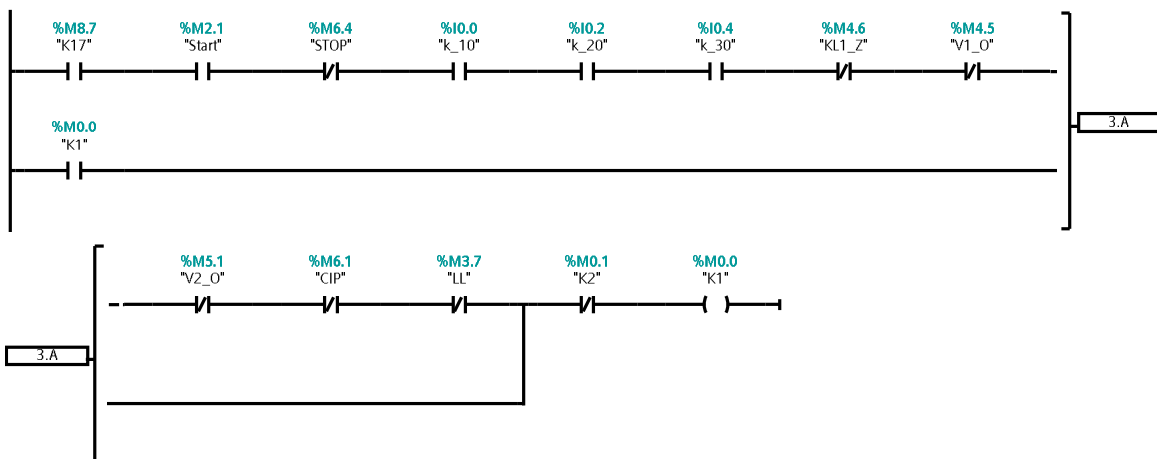

Network 4:

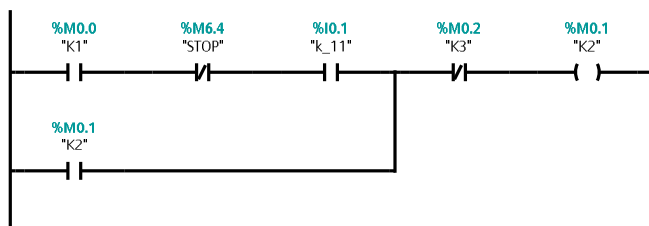

Network 5:

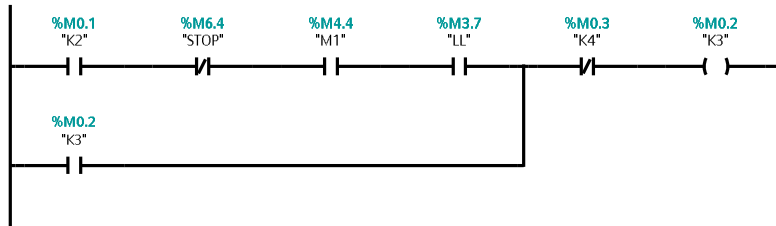

Network 6:

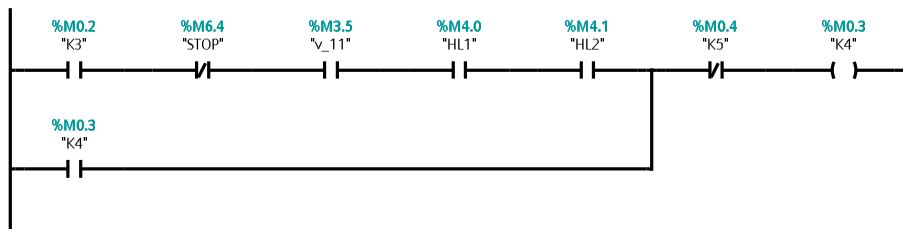

Network 7:

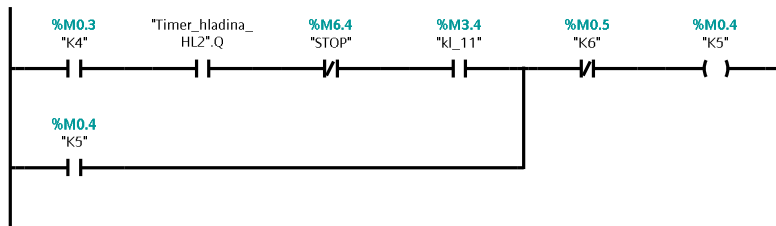

Network 8:

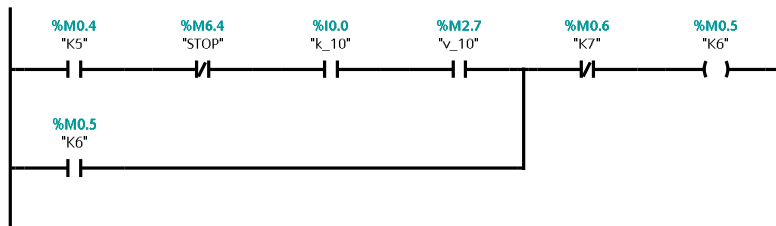

Network 9:

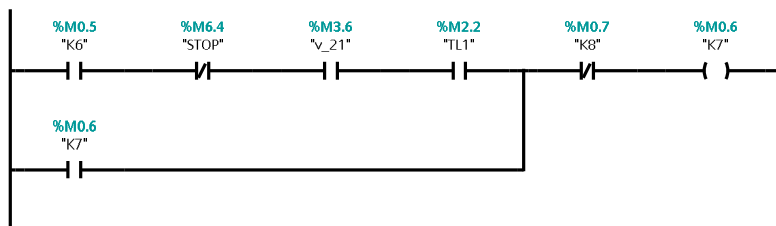

Network 10:

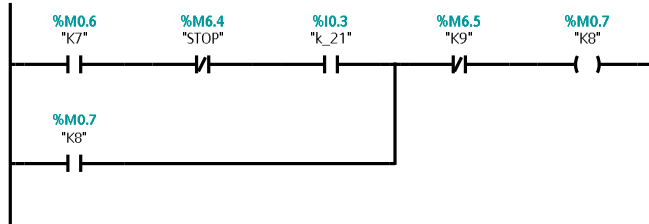

Network 11:

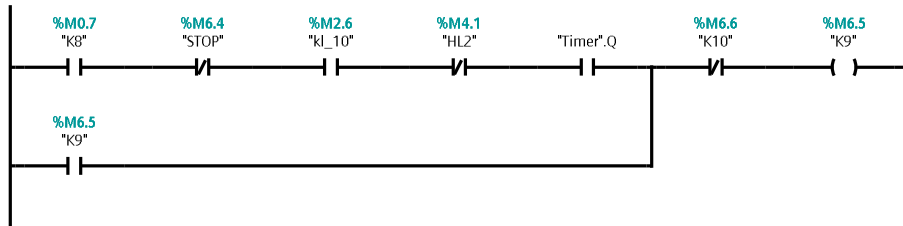

Network 12:

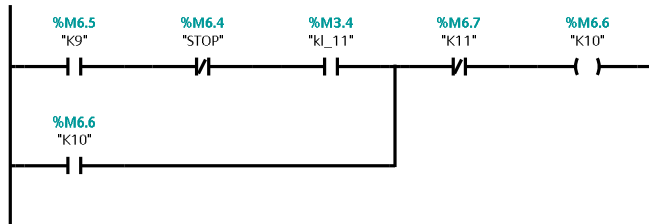

Network 13:

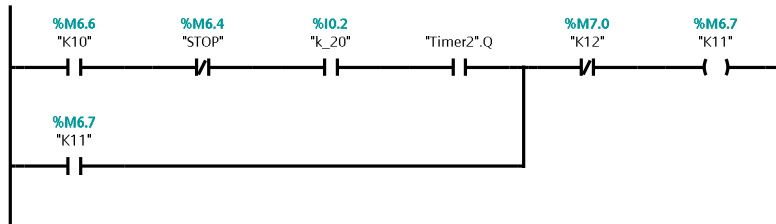

Network 14:

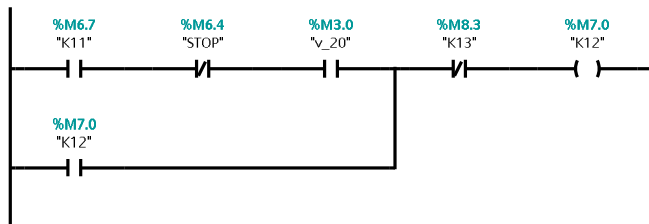

Network 15:

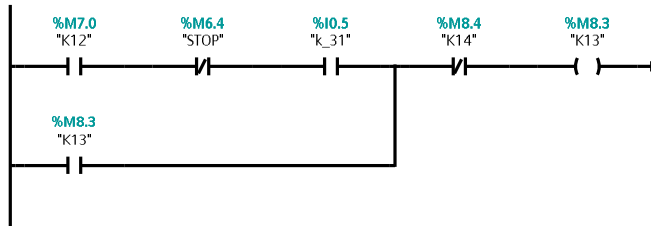

Network 16:

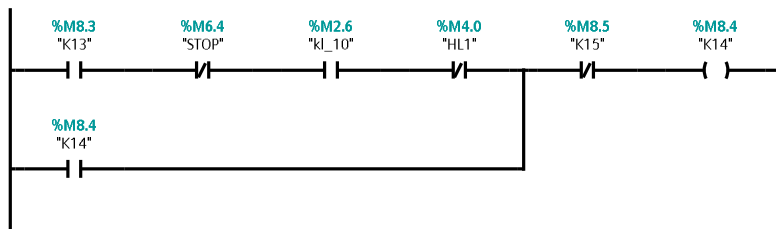

Network 17:

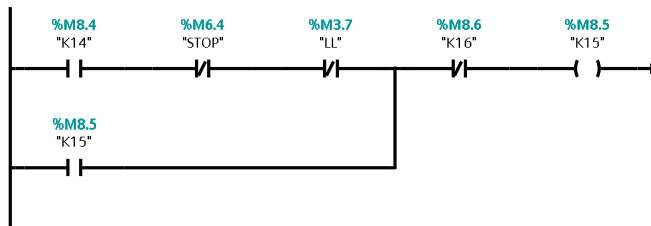

Network 18:

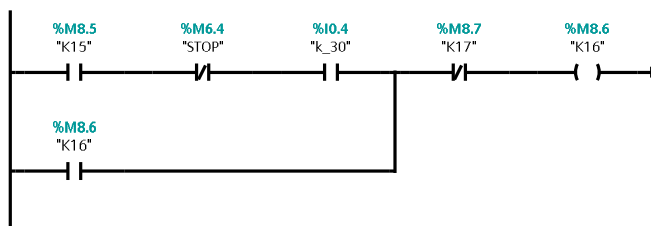

Network 19:

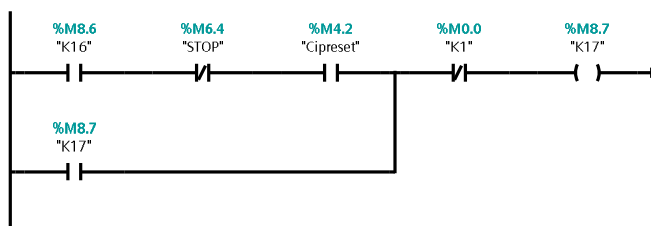

Network 20:

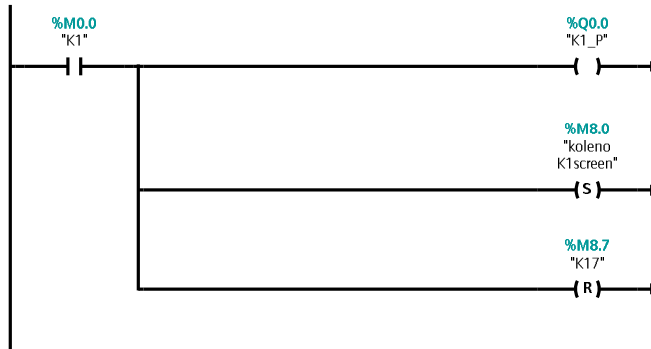

Network 21:

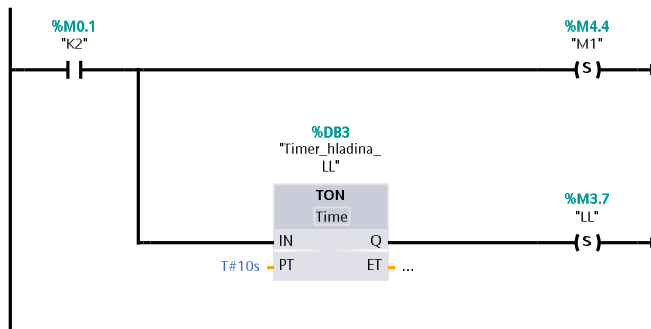

Network 22:

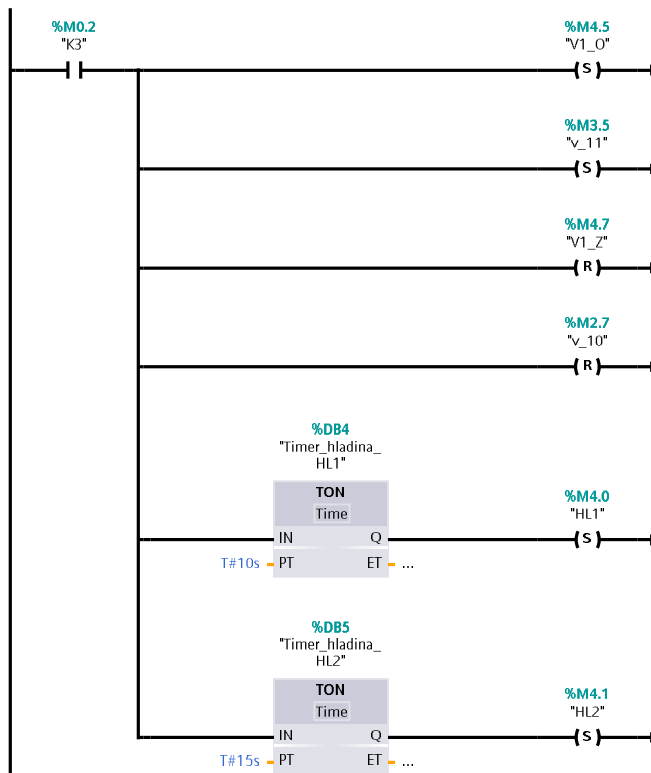

Network 23:

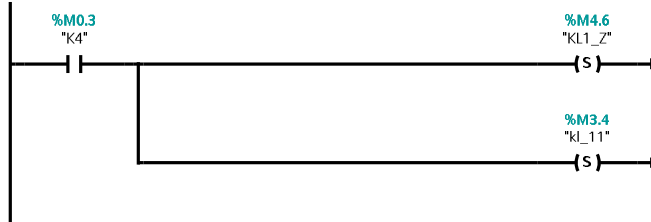

Network 24:

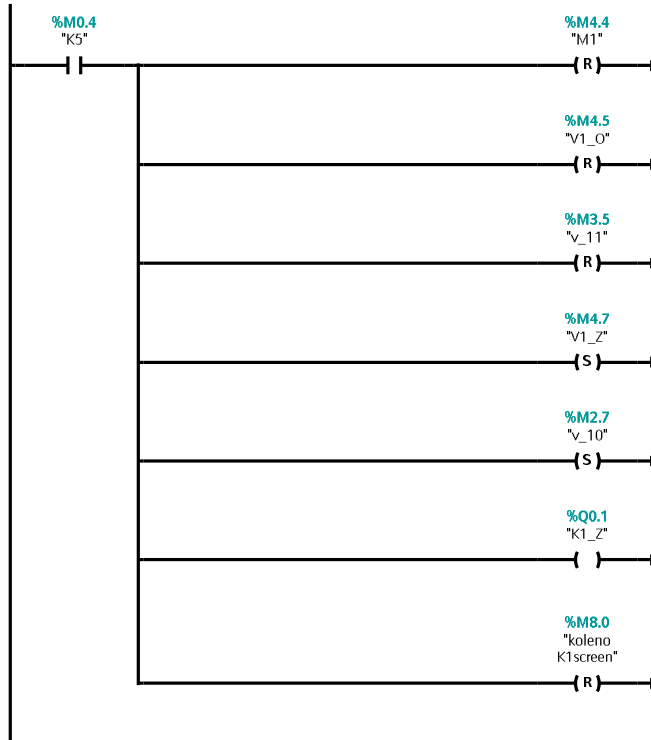

Network 25:

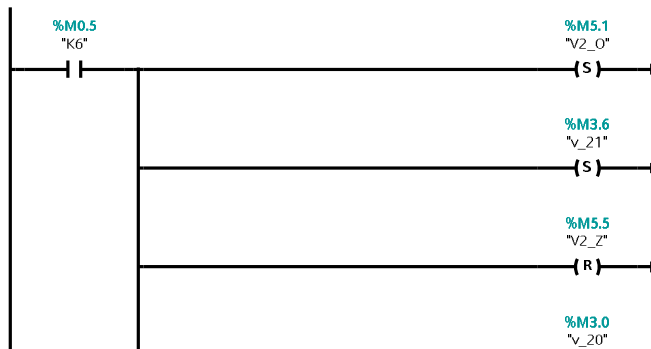

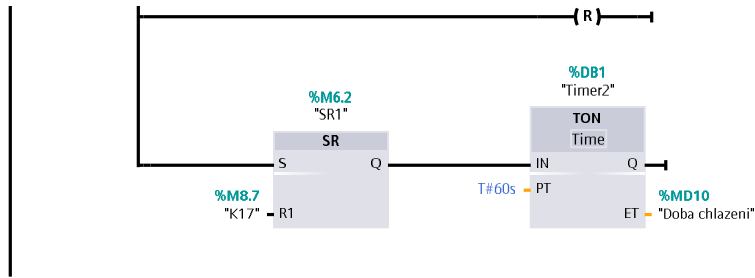

Network 26:

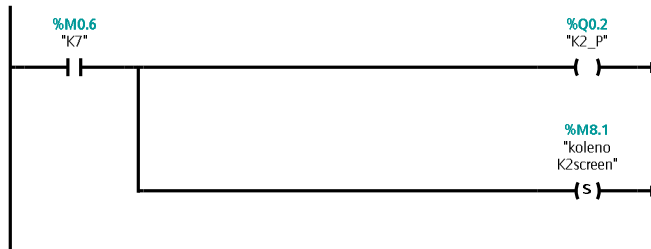

Network 27:

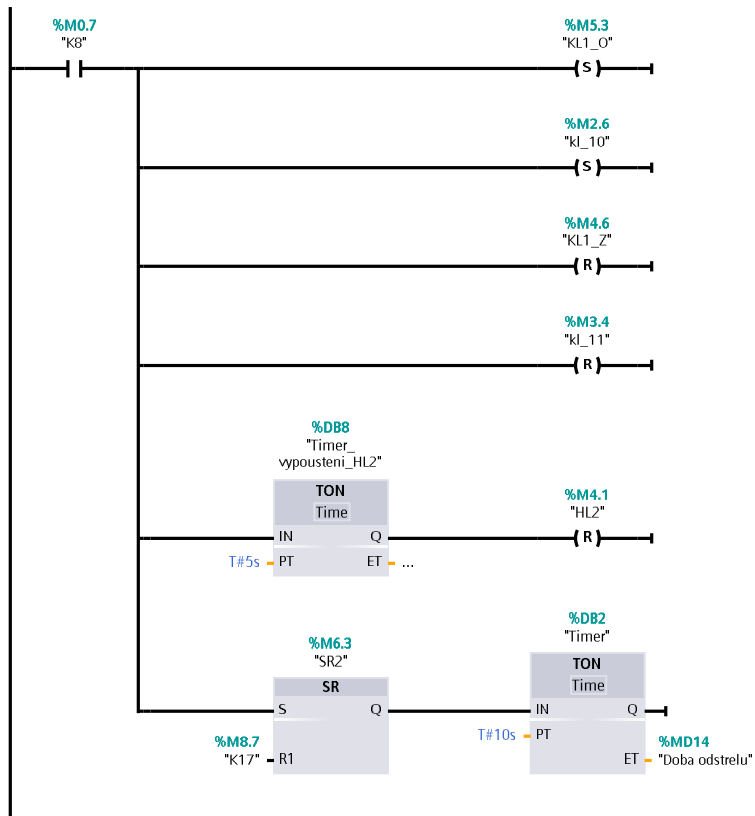

Network 28:

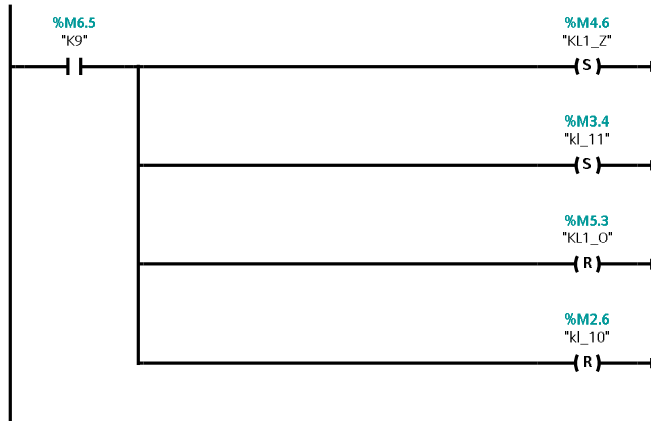

Network 29:

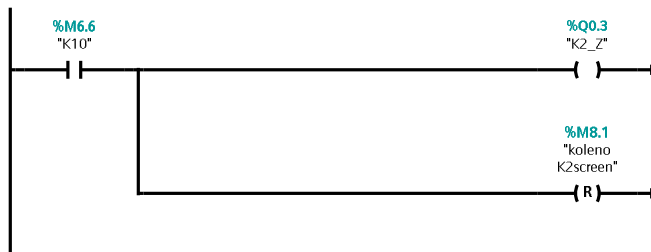

Network 30:

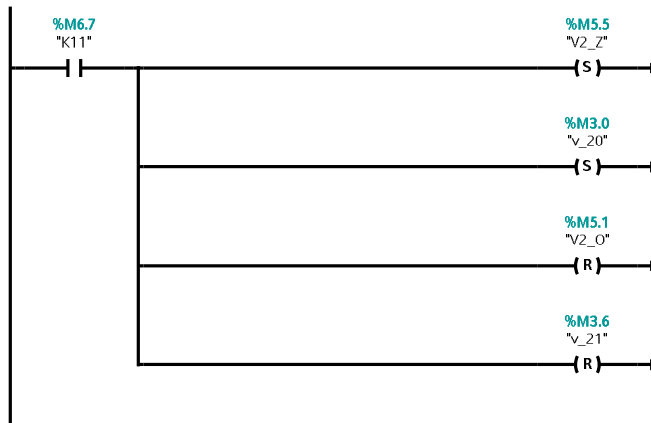

Network 31:

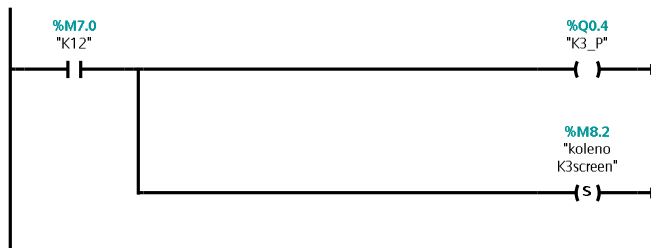

Network 32:

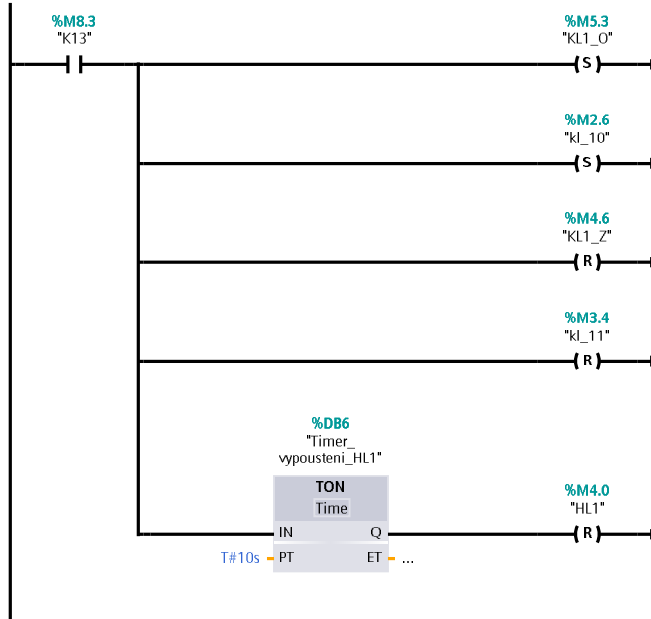

Network 33:

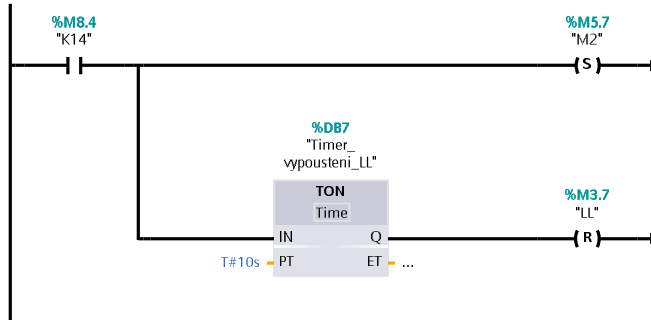

Network 34:

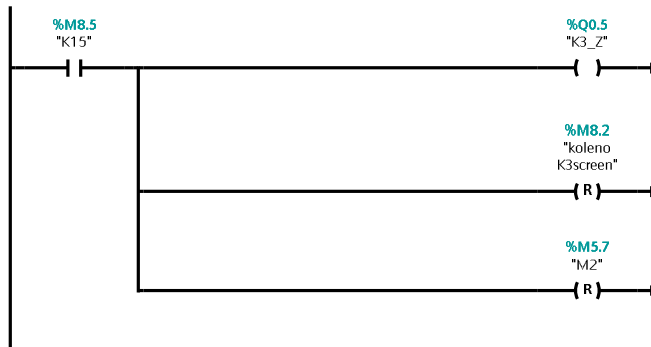

Network 35:

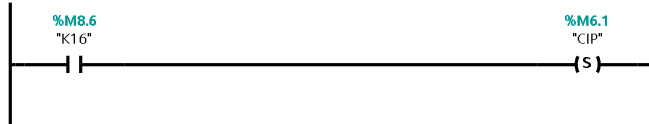

Network 36:

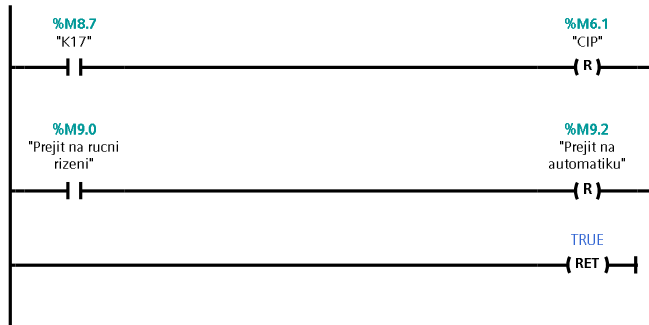

Network 37:

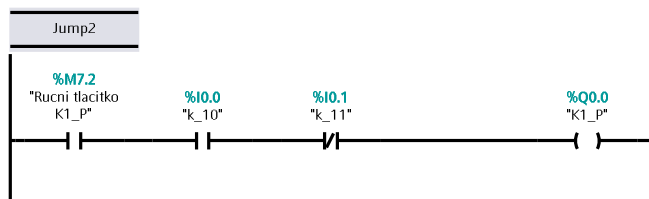

Network 38:

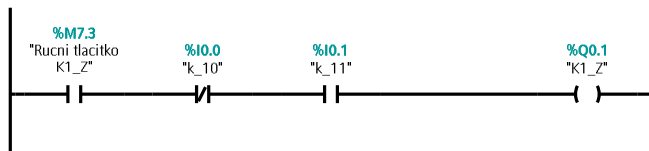

Network 39:

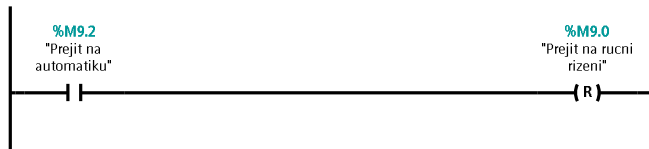

Network 40:

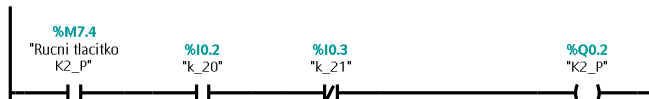

Network 41:

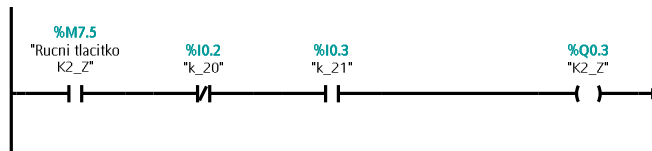

Network 42:

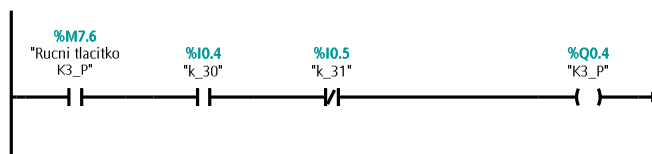

Network 43:

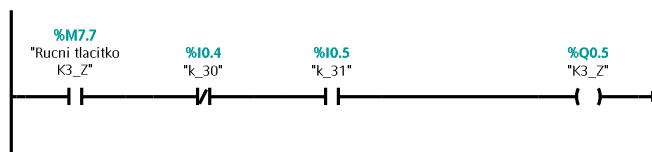

Network 44:

